

EN

# HandyPlasma 35i HandyPlasma 45i



## OPERATING MANUAL

HandyPlasma 35i  
HandyPlasma 45i

05/2020 - Revision: AA

0559160135  
0559160145

Manual No.: 0-5584



**Be sure this information reaches the operator.  
You can get extra copies through your supplier.**

## **CAUTION**

**These INSTRUCTIONS are for experienced operators. If you are not fully familiar with the principles of operation and safe practices for arc welding and cutting equipment, we urge you to read our booklet, "Precautions and Safe Practices for Arc Welding, Cutting, and Gouging," Booklet 0-5407. Do NOT permit untrained persons to install, operate, or maintain this equipment. Do NOT attempt to install or operate this equipment until you have read and fully understand these instructions. If you do not fully understand these instructions, contact your supplier for further information. Be sure to read the Safety Precautions before installing or operating this equipment.**

## **USER RESPONSIBILITY**

This equipment will perform in conformity with the description thereof contained in this manual and accompanying labels and/or inserts when installed, operated, maintained and repaired in accordance with the instructions provided. This equipment must be checked periodically. Malfunctioning or poorly maintained equipment should not be used. Parts that are broken, missing, worn, distorted or contaminated should be replaced immediately. Should such repair or replacement become necessary, the manufacturer recommends that a telephone or written request for service advice be made to the Authorized Distributor from whom it was purchased.

This equipment or any of its parts should not be altered without the prior written approval of the manufacturer. The user of this equipment shall have the sole responsibility for any malfunction which results from improper use, faulty maintenance, damage, improper repair or alteration by anyone other than the manufacturer or a service facility designated by the manufacturer.



**How To Use This Manual.  
PROTECT YOURSELF AND OTHERS!**

**ASSUREZ-VOUS QUE CE DOCUMENT D'INFORMATION EST DISTRIBUÉ À L'OPÉRATEUR.  
DES COPIES SUPPLÉMENTAIRES SONT DISPONIBLES CHEZ VOTRE FOURNISSEUR.**

## **MISE EN GARDE**

Les **INSTRUCTIONS** suivantes sont destinées aux opérateurs qualifiés seulement. Si vous n'avez pas une connaissance approfondie des principes de fonctionnement et des règles de sécurité applicables au soudage à l'arc et à l'équipement de coupage, nous vous suggérons de lire notre brochure « Précautions et pratiques de sécurité pour le soudage à l'arc, le coupage et le gougeage », Formulaire 52-529. Ne permettez **PAS** aux personnes non qualifiées d'installer, d'utiliser ou d'effectuer des opérations de maintenance sur cet équipement cet équipement. Ne tentez **PAS** d'installer ou d'utiliser cet équipement avant d'avoir lu et bien compris ces instructions. Si vous ne comprenez pas bien les instructions, renseignez-vous auprès de votre fournisseur. Assurez-vous de lire les Règles de Sécurité avant d'installer ou d'utiliser cet équipement.

## **RESPONSABILITÉS DE L'UTILISATEUR**

Cet équipement fonctionnera conformément à la description contenue dans ce manuel, les étiquettes d'accompagnement et/ou les feuillets d'information à condition d'être installé, utilisé, entretenu et réparé selon les instructions fournies. L'équipement doit être contrôlé de manière périodique. Ne jamais utiliser un équipement qui ne fonctionne correctement bien ou n'est pas bien entretenu. Les pièces qui sont brisées, usées, déformées ou contaminées doivent être remplacées immédiatement. Dans le cas où une réparation ou un remplacement est nécessaire, le fabricant recommande de faire une demande de conseil de service écrite ou par téléphone auprès du distributeur agréé où l'équipement a été acheté.

Cet équipement ou ses pièces ne doivent pas être modifiés sans permission préalable écrite du fabricant. L'utilisateur de l'équipement sera le seul responsable de toute défaillance résultant de toute utilisation, maintenance, réparation incorrectes, de dommages ou encore de modification apportées par une personne autre que le fabricant ou un centre de service désigné par ce dernier.

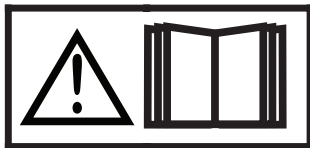

**ASSUREZ-VOUS DE LIRE ET DE COMPRENDRE LE MANUEL D'UTILISATION AVANT  
D'INSTALLER OU D'UTILISER L'UNITÉ.  
PROTÉGEZ-VOUS ET LES AUTRES!**



## DECLARATION OF CONFORMITY

According to

The Arc Welding Power Source Directive EN 60974-10:2015+A1:2015, EN IEC 60974-1:2018,  
ANSI/IEC 60974-1:2008

### Type of equipment

Plasma Cutting Power Source

### Type designation etc.

Cutting Performance

### Brand name or trade mark

HandyPlasma

### Manufacturer or his authorized representative established within the EEA

#### Name, address, telephone No:

ESAB  
2800 Airport Rd.  
Denton, TX, 76207  
Phone: 001 843 669 4411

### The following harmonised standard in force within the EEA has been used in the design:

IEC/EN 60974-1:2017 / AMD1:2019 Arc Welding Equipment - Part 1: Welding power sources.  
IEC/EN 60974-10:2014 + AMD 1:2015 Published 2015-06-19 Arc Welding Equipment - Part 10: Electro-  
magnetic compatibility (EMC) requirements

*Additional Information: Restrictive use, Class A equipment, intended for use in location other than residential.*

**By signing this document, the undersigned declares as manufacturer, or the manufacturer's authorized representative established within the EEA, that the equipment in question complies with the safety requirements stated above.**

**Date**

**Signature**

**Position**

31-01-2020

A handwritten signature in black ink, appearing to read 'Flavio Santos'.

Flavio Santos

General Manager,  
Accessories and Adjacencies





**WARNING**

Read and understand this entire Manual and your employer's safety practices before installing, operating, or servicing the equipment.  
While the information contained in this Manual represents the Manufacturer's best judgment, the Manufacturer assumes no liability for its use.

**Published by:**  
ESAB  
2800 Airport Rd.  
Denton, TX 76208

Copyright 2020 by ESAB. All rights reserved.

**TABLE OF CONTENTS**

**1 SAFETY ..... 6**

**2 INTRODUCTION ..... 7**

    2.1 How To Use This Manual .....7

    2.2 HandyPlasma features .....8

    2.3 Equipment Identification/ User responsibility .....9

**3 TECHNICAL DATA ..... 10**

    3.1 Generator Recommendations ..... 11

**4 INSTALLATION ..... 12**

    4.1 General ..... 12

    4.2 Environment ..... 12

    4.3 Workplace ..... 12

    4.4 Power grid requirements ..... 12

    4.5 Power supply cables ..... 13

    4.6 Air connections ..... 14

    4.7 Torch and Lead connections ..... 16

**5 OPERATION ..... 17**

    5.1 Overview ..... 17

    5.2 Control panel ..... 17

    5.3 LCD Display operation ..... 20

**6 MAINTENANCE ..... 30**

    6.1 Overview ..... 30

    6.2 Preventive maintenance ..... 30

    6.3 Corrective maintenance ..... 30

    6.4 Equipment preventive maintenance plan ..... 31

**7 PLASMA TORCH ..... 32**

    7.1 Specifications ..... 32

    7.2 Introduction to Plasma ..... 33

    7.3 Torch maintenance ..... 34





**8 TROUBLESHOOTING GUIDE ..... 35**

**9 PARTS LISTS ..... 36**

    9.1 Consumable Parts for 60A Torch (P/N 0559337000) ..... 36

    9.2 Options and Accessories ..... 36

# 1 SAFETY

 				 <b>WARNING</b>	 <b>AVERTISSEMENT</b>
1	1.1	1.2	1.3	<b>1. Cutting sparks can cause explosion or fire.</b> 1.1 Do not cut near flammables. 1.2 Have a fire extinguisher nearby and ready to use. 1.3 Do not use a drum or other closed container as a cutting table.	<b>1. Les étincelles de coupage peuvent provoquer une explosion ou un incendia.</b> 1.1 Ne pas couper près des matières inflammables. 1.2 Un extincteur doit être à proximité et prêt à être utilisé. 1.3 Ne pas utiliser un fût ou un autre contenant fermé comme table de coupage.
2	2.1	2.2	2.3	<b>2. Plasma arc can injure and burn; point the nozzle away from yourself. Arc starts instantly when triggered.</b> 2.1 Turn off power before disassembling torch. 2.2 Do not grip the workpiece near the cutting path. 2.3 Wear complete body protection.	<b>2. L'arc plasma peut blesser et brûler; éloigner la buse de soi. Il s'allume instantanément quand on l'amorce</b> 2.1 Couper l'alimentation avant de démonter la torche. 2.2 Ne pas saisir la pièce à couper de la trajectoire de coupage. 2.3 Se protéger entièrement le corps.
3	3.1	3.2	3.3	<b>3. Hazardous voltage. Risk of electric shock or burn.</b> 3.1 Wear insulating gloves. Replace gloves when wet or damaged. 3.2 Protect from shock by insulating yourself from work and ground. 3.3 Disconnect power before servicing. Do not touch live parts.	<b>3. Tension dangereuse. Risque de choc électrique ou de brûlure.</b> 3.1 Porter des gants isolants. Remplacer les gants quand ils sont humides ou endommagés. 3.2 Se protéger contre les chocs en s'isolant de la pièce et de la terre. 3.3 Couper l'alimentation avant l'entretien. Ne pas toucher les pièces sous tension.
4	4.1	4.2	4.3	<b>4. Plasma fumes can be hazardous.</b> 4.1 Do not inhale fumes. 4.2 Use forced ventilation or local exhaust to remove the fumes. 4.3 Do not operate in closed spaces. Remove fumes with ventilation.	<b>4. Les fumées plasma peuvent être dangereuses.</b> 4.1 Ne pas inhaler les fumées. 4.2 Utiliser une ventilation forcée ou un extracteur local pour dissiper les fumées. 4.3 Ne pas couper dans des espaces clos. Chasser les fumées par ventilation.
5	5.1			<b>5. Arc rays can burn eyes and injure skin.</b> 5.1 Wear correct and appropriate protective equipment to protect head, eyes, ears, hands, and body. Button shirt collar. Protect ears from noise. Use welding helmet with the correct shade of filter.	<b>5. Les rayons d'arc peuvent brûler les yeux et blesser la peau.</b> 5.1 Porter un bon équipement de protection pour se protéger la tête, les yeux, les oreilles, les mains et le corps. Boutonner le col de la chemise. Protéger les oreilles contre le bruit. Utiliser un masque de soudeur avec un filtre de nuance appropriée.
6				<b>6. Become trained.</b> Only qualified personnel should operate this equipment. Use torches specified in the manual. Keep non-qualified personnel and children away.	<b>6. Suivre une formation.</b> Seul le personnel qualifié a le droit de faire fonctionner cet équipement. Utiliser exclusivement les torches indiquées dans le manuel. Le personnel non qualifié et les enfants doivent se tenir à l'écart.
7				<b>7. Do not remove, destroy, or cover this label.</b> Replace if it is missing, damaged, or worn.	<b>7. Ne pas enlever, détruire ni couvrir cette étiquette.</b> La remplacer si elle est absente, endommagée ou usée.

Art # A-13294

## 2 INTRODUCTION

### 2.1 How To Use This Manual.

#### PROTECT YOURSELF AND OTHERS!

To ensure safe operation, read the entire manual, including the chapter on safety instructions and warnings. Throughout this manual, the words DANGER, WARNING, CAUTION, and NOTE may appear. Pay particular attention to the information provided under these headings. These special annotations are easily recognized as follows:

**NOTE!**

An operation, procedure, or background information which requires additional emphasis or is helpful in efficient operation of the system.

**WARNING**

A procedure which, if not properly followed, may cause injury to the operator or others in the operating area.

**CAUTION**

A procedure which, if not properly followed, may cause damage to the equipment.

**WARNING**

Gives information regarding possible electrical shock injury. Warnings will be enclosed in a box such as this.

**DANGER**

Means immediate hazards which, if not avoided, will result in immediate, serious personal injury or loss of life.

Electronic copies of this manual can be downloaded in Acrobat PDF format by going to the ESAB web site listed below: Enter manual part number.  
<http://www.esab.com>



Arc Current (Amps)	Minimum Protector Matrix No.	Suggested Matrix No. (comfort)
Less than 20	4	7
20-40	5	7
40-60	6	7

## 2.2 HandyPlasma features

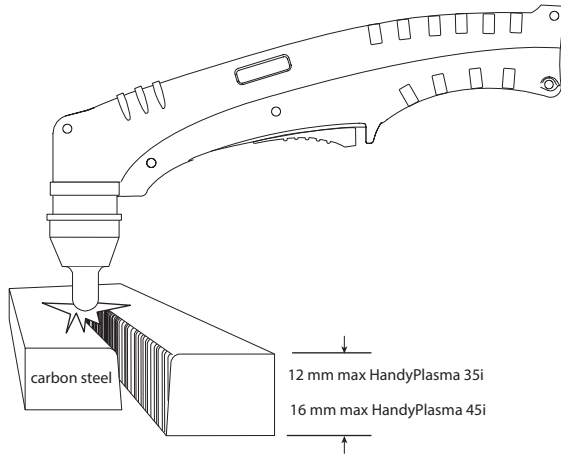

### Front Panel Controls

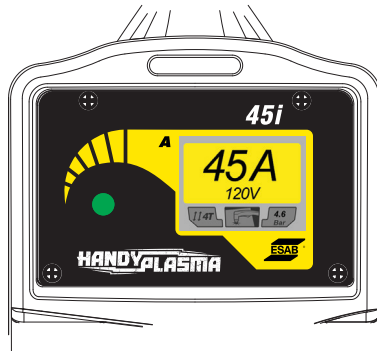

The HandyPlasma equipment provides excellent cutting performance when used with the correct consumables and plasma cutting procedures. The following instructions detail the appropriate safe configuration of the equipment and provide directives to obtain the best efficiency and quality.

Carefully read these instructions before using.



### 2.3 Equipment Identification/ User responsibility



Inspect each item regarding possible damage during shipping. If the damage is evident, contact your distributor and/or carrier before proceeding with the installation.

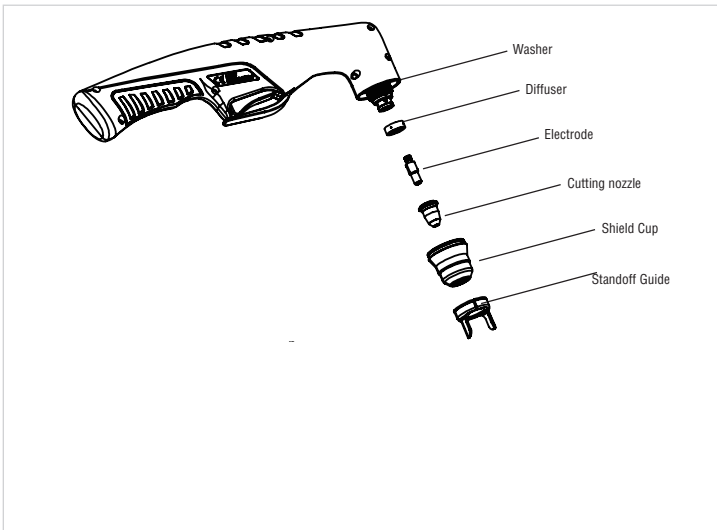

Include all equipment identification numbers, along with a full description of the missing or parts damaged.

### 3 TECHNICAL DATA

#### Duty Cycle

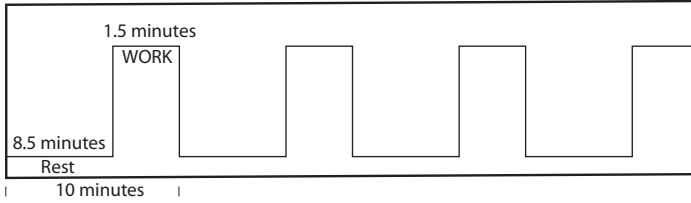

#### WARNING!

The work cycle is the percentage of time during which the equipment can be operated without overheating.

#### Protection class

The IP code indicates the enclosure class, i.e. the degree of protection against penetration by solid objects or water.

#### Application class

The symbol **S** indicates that the power supply was designed for use in areas with high electrical risks.

TABLE 3.1		
TECHNICAL DATA		
INVERTER	HANDYPLASMA	
Equipment development technology	Inverter	
Equipment model	HandyPlasma 35i	HandyPlasma 45i
Efficiency	84% @35A/94V	84% @45A/98V
Idle state power consumption	35 W	35 W
Network voltage	220-240V - 1Ø	
Network frequency	50/60 Hz	
Current range	20 - 35 A (DC)	20 - 45 A (DC)
Work cycle	28 A / 91,2V @ 60% 35 A / 94V @ 35% 22 A / 88,8V @ 100%	35 A / 94 V @ 60% 45 A / 98 V @ 35% 30 A / 92 V @ 100%
Dimensions (W x L x H)	176 x 415 x 324 mm	
Weight	13,5 kg	
Recommended air input requirements	6-8 Bar (87-116 PSI)	
Recommended air flow	110 LPM	
Open circuit voltage	315V	315V
Operating temperature	0°C to 40°C	
Power factor at the maximum current output	0.99	
IP Rating	IP 21S	
Apparent Power	9 kVA	10 kVA
Recommended circuit breaker or fuses at maximum output	11 A	15,4 A
Rated power consumption	6.4KW	7.2 KW

**WARNING!**

Do not operate this machine above its rated capacity.

**WARNING!**

The air supply must be free from oil, humidity, and other contaminants. Excessive oil and humidity may cause double arcs, quick tip wear, or even complete torch failure. Contaminants may cause poor cutting performance and quick electrode wear. Optional filters provide higher filtering capacity.

**NOTE!**

The IEC Classification is determined as specified by the International Electrotechnical Commission. These specifications include the output voltage calculation based on the equipment rated current. To allow easy comparison between pieces of equipment, all manufacturers use this output voltage to establish the operation cycle.

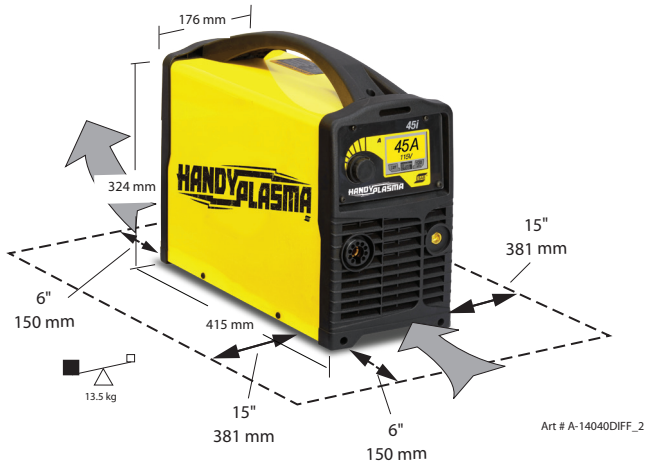

Figure 3.1 - Dimensions and weight of the power supply

**NOTE!**

The weight includes the equipment, torch, consumables, input power cable, and work clamp.

### 3.1 Generator Recommendations

When using generators to power the plasma cutting system, the following minimum specifications must be considered to select the power generator.

TABLE 3.2	
MODEL	GENERATOR RATED OUTPUT
HandyPlasma 35i	8 kVA (with power factor of 0.8) 6.4 KW (with power factor of 1.0)
HandyPlasma 45i	9 kVA (with power factor of 0.8) 7.2 KW (with power factor of 1.0)

## 4 INSTALLATION

### 4.1 General

The equipment must be installed by trained and qualified professionals.



#### WARNING!

**This product was designed for industrial use.** The user is responsible for taking the appropriate measures.

### 4.2 Environment

This equipment was designed for use in environments with higher risk of electric shock.

A. The examples of environments with higher risk of electric shock include:

1. Areas in which freedom of movement is restricted, and the operator is forced to work in a limited position (on his knees, sitting down, or laying down) with physical contact with conductive parts.
2. Areas completely or partially limited by conductive elements and in which there is high risk of inevitable or accidental operator contact.

B. Environments with higher risk of electric shock do not include areas in which conductive parts close to the operator, which could cause elevated risk, have been insulated.

### 4.3 Workplace

To operate the equipment safely, ensure that the workplace:



A.



B.



C.

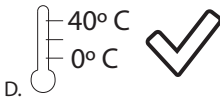

D.

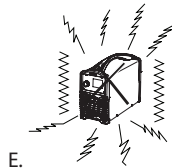

E.

### 4.4 Power grid requirements

The power grid voltage must be within  $\pm 10\%$  of the rated power grid voltage. If the real power grid voltage is outside this range, the welding current may change causing internal component failure and impaired equipment performance.

The cutting machine must be:

- Installed correctly, by a qualified electrician.
- Grounded correctly (electrically) according to the local standards. Refer to Local and National Codes or local authority having jurisdiction for proper wiring requirements.
- Connected to the power grid with a duly specified fuse.



**WARNING!**

All electrical work must be performed by a qualified expert electrician.



**WARNING!**

The grounding terminal is connected to the power supply body via the HandyPlasma plug. It must be connected to a grounding point of the workplace electrical installation. Take care not to invert the input cable ground conductor (green/yellow cable) at any of the main switch of circuit breaker phases, because this applies electrical voltage to the body.



**NOTE!**

Do not use the network neutral as ground.

All electrical connections must be firmly tightened in order to avoid risk of sparks, overheating, or circuit voltage drop.

### 4.5 Power supply cables



**NOTE!**

The HandyPlasma equipment includes an appropriate input power cable to supply the 220~240 VAC single-phase input. Customer is responsible for connecting the HandyPlasma to the appropriate voltage range from the grid. Attempting to plug in voltage ABOVE this range will cause damage.

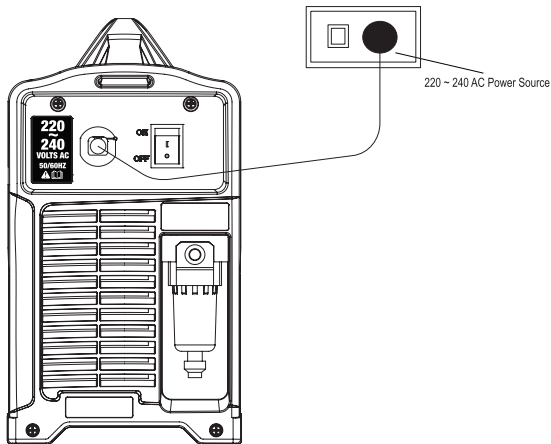

Figure 4.1 - HandyPlasma power supply

When the equipment input voltage is **below** the safe operation range, the Voltage Error Screens are displayed when the cutting process is initiated.

If the power supply voltage exceeds the safe work voltage range continuously, the equipment service life may be reduced.

## 4.6 Air connections

### Air adapter assembly:



**NOTE!**

For a secure seal, apply thread sealant to the fitting threads, according to manufacturer's instructions. Do not use Teflon tape as a thread sealer, as small particles of the tape may break off and block the small air passages in the torch.

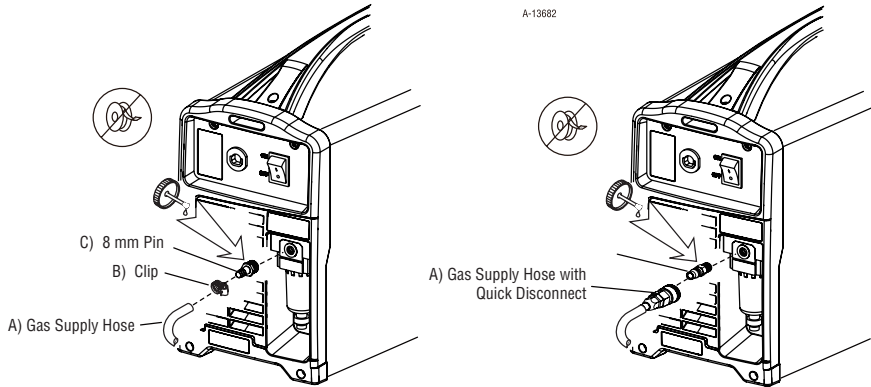

Figure 4.2 - Gas connection to compressed air input.

### Using industrial compressed air in gas cylinders or a compressor



**WARNING!**

The cylinders must be equipped with adjustable high-pressure regulators, for output pressures of up to 6-8 bar and flows of at least 110 LPM.

A compressor must be equipped with output pressure regulators of up to 6-8 bar and flows of at least 110 LPM.

When industrial compressed air in gas cylinders is used as gas supply:

1. Check the manufacturer's specifications regarding the installation and maintenance procedures applied to high-pressure gas regulators.
2. Inspect the cylinder valves to ensure that they are clean and free from oil, grease, or any other foreign materials. Briefly open each cylinder valve to blow any dust that may be present.
3. Connect the gas supply hose to the cylinder.

### Installing Optional Inline Filter

An optional inline filter is recommended for improved filtering with compressed air and keeping moisture or debris out of the torch.

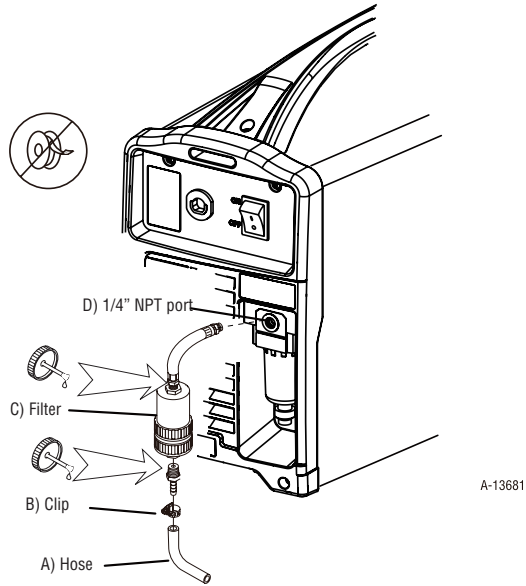

Figure 4.3 - Connecting Inline Filter



#### NOTE!

Adjust the gas cylinder pressure between 6 and 8 bar. The internal diameter of the supply hose must be at least 6 mm. For a secure seal, apply thread sealant to the fitting threads, according to manufacturer's instructions. Do not use Teflon tape as a thread sealer, as small particles of the tape may break off and block the small air passages in the torch.

## 4.7 Torch and Lead connections

### Ground Lead connection

Ensure connection to ground terminal with the 25 mm connector. The plasma cutting current flows through the ground terminal.



#### NOTE!

It is essential that the plug is inserted and rotated into place securely to obtain a electrical connection.



### Torch connection

To install the HandyPlasma torch. Push sleeve in and rotate.

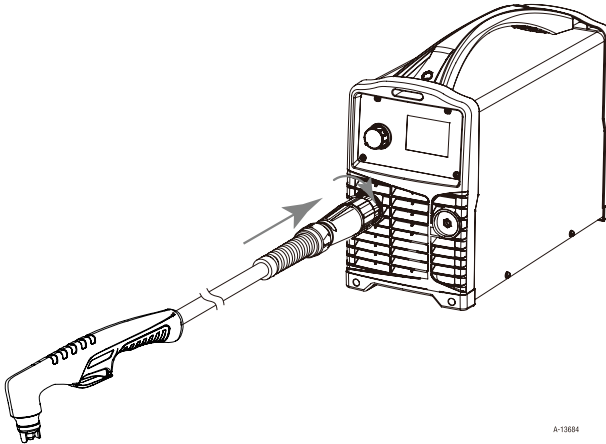

A-13884

Figure 4.4 - Plasma torch connection



## 5 OPERATION

### 5.1 Overview

The general safety regulations to handle the equipment are found in section 1. Read and understand the instruction manual before installing or operating.

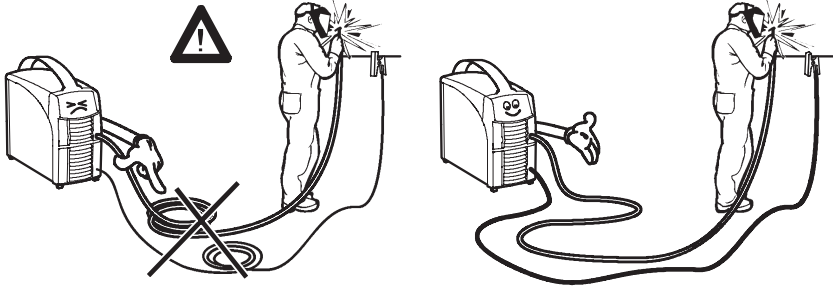

**CAUTION!**

The user is responsible for defining the process and respective cutting procedure of the consumables (wire, gas) and for the results of the operation and application.



**CAUTION!**

Do not turn the power supply OFF during cutting (with load).

### 5.2 Control panel

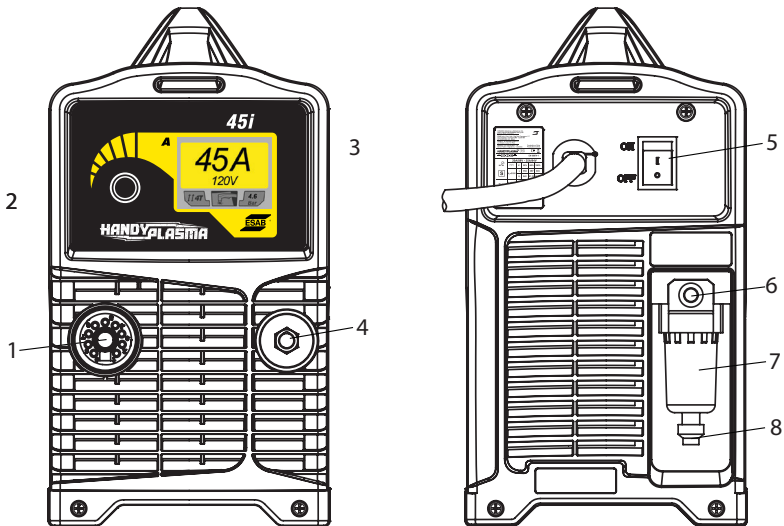
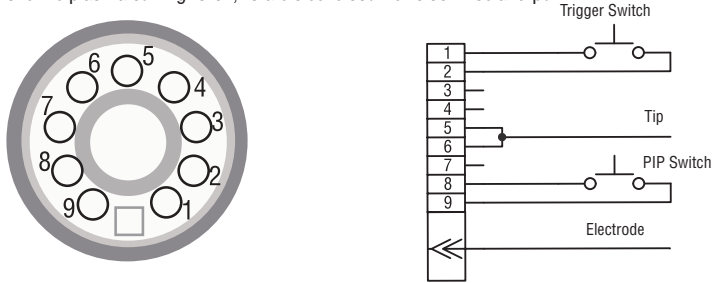

Figure 5.1 - HandyPlasma 35i/45i

## 1. Plasma torch adapter

The adapter is the connection point for the plasma cutting torch.

To remove the plasma cutting torch, rotate sleeve counter-clockwise and pull.



A-13903

Figure 5.2 - Plasma torch connection

SOCKET PIN	FUNCTION
1	Torch trigger
2	Torch trigger
3	No connection
4	No connection
5	Tip
6	Tip
7	No connection
8	PIP switch
9	PIP switch
Socket central	Electrode

Pinout table

## 2. Control button

To select the menu or change values.

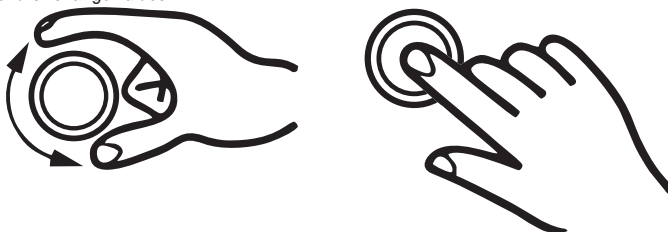

Figure 5.3 - Control button

### To adjust the cutting current:

- Turn clockwise to increase the cutting current;
- Turn counter-clockwise to reduce the cutting current.

### To select an option in the menu displayed:

- The options are highlighted in sequence at each turn.



- Select the icon on the main screen. To exit the menu.



### 3. LCD screen

The front panel has an LCD screen to display the cutting mode, cutting current, air pressure, and error information.

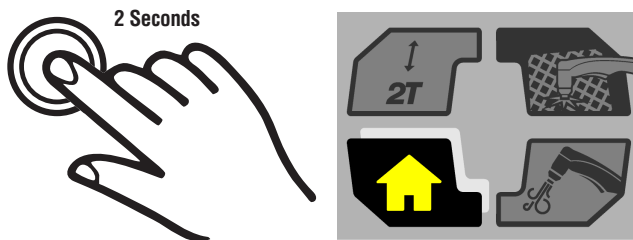
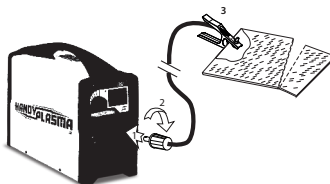

Figure 5.4 - LCD screen

### 4. Work clamp terminal



#### CAUTION!

Loose terminal connections may cause overheating and fusion of the male terminal on the OKC female terminal.

### 5. ON/OFF switch

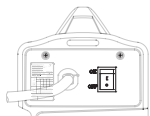

When the switch is ON, the front panel LCE screen lights up and the fan starts.

### 6. Gas connector

The equipment gas input may accept 1/4" NPT male plugs and peg-type air connection nozzles, which are supplied in the compressed air line connection package.



#### CAUTION!

For a secure seal, apply thread sealant to the fitting threads, according to manufacturer's instructions. Do not use Teflon tape as a thread sealer, as small particles of the tape may break off and block the small air passages in the torch.

## 7. Water collector

The water collector equipped collects the water in the compressed air.

## 8. Water release valve

Push the water release valve up to release the water collected in the filter bowl. Use the wrench supplied with the system package to release the filter bowl for cleaning or filter replacement.



### CAUTION!

Do not remove bowl under pressure. Disconnect air line before performing this task.

## 5.3 LCD Display operation

### WELCOME SCREEN

The welcome screen is displayed for 3 seconds while the equipment turns ON.



Figure 5.5 - Welcome screen

After the welcome screen, the model name is displayed for 3 seconds.



Figure 5.6 - Name screen according to the model

### MAIN SCREEN

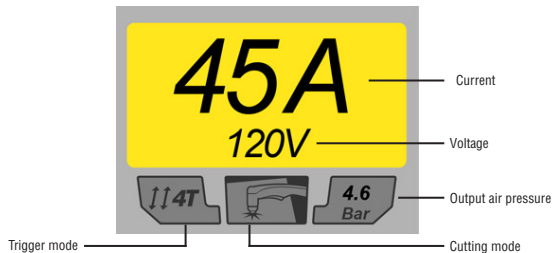



Figure 5.7 - Main screen

## MENU SCREEN

To enter the menu screen.  In the menu screen, the user may adjust the trigger mode, cutting mode, and gas purge. To exit the menu screen, select the main screen icon.

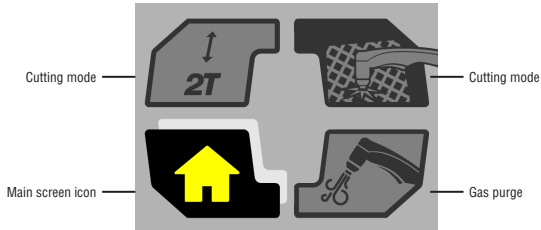

Figure 5.8 - Menu screen

### 1) TRIGGER MODE SELECTION SCREEN

When the trigger mode section is highlighted to enter the 2T/4T selection screen. 

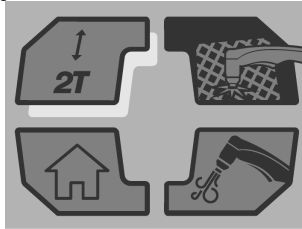
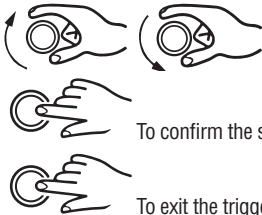

Figure 5.9 - Trigger mode screen selected



To change the selection between 2T and 4T.

To confirm the selection.

To exit the trigger mode selection screen.

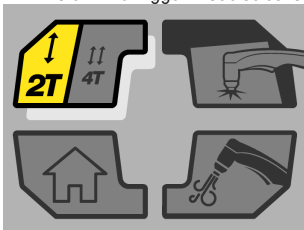

Figure 5.10 - Mode 2T selected

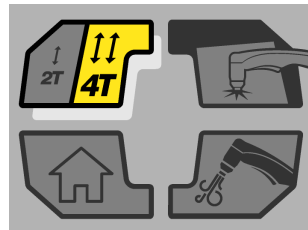
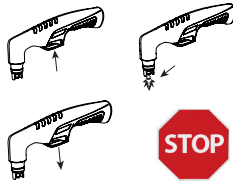

Figure 5.11 - Mode 4T selected

The trigger mode is used to change the torch trigger functionality between 2T (normal) and 4T (lock mode).

In the 2T mode, the torch trigger must remain pressed to activate the cutting output.



The 4T mode is used mainly for long cutting operations in order to reduce operator fatigue.

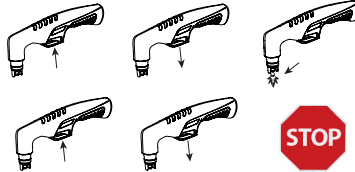

## 2) CUTTING MODE SELECTION SCREEN



To enter the cutting mode selection.



When the cutting mode is highlighted.

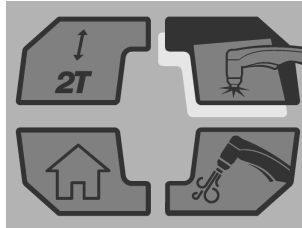

Figure 5.12 - Cutting mode selected



To change the selection between the plate cutting mode and the grid mode.



To confirm the selection.



To exit the cutting mode selection screen.

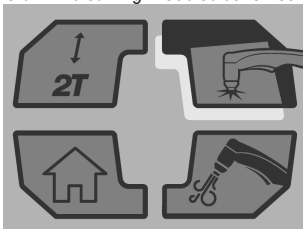

Figure 5.13 - Plate cutting mode

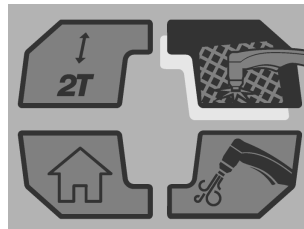
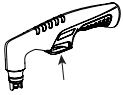

Figure 5.14 - Grid cutting mode

Note that when the trigger mode is defined as 4T, the grid cutting mode is not available.

In the plate cutting mode with the trigger mode 2T selected, the arc stops when the torch is pulled away from the workpiece during the cutting operations.



To restart the pilot arc.

In the grid cutting mode, when the torch is pulled away from the workpiece, the pilot arc is restarted instantaneously and the cutting arc activates instantaneously when the pilot arc gets in contact with the workpiece. It is advisable to select the grid cutting mode to cut expanded metal or grids or to perform grinding operations, when uninterrupted reinitialization is desired.

### 3) GAS PURGE SCREEN

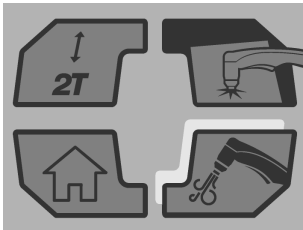

Figure 5.15 - Gas purge screen selected

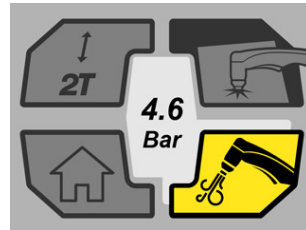
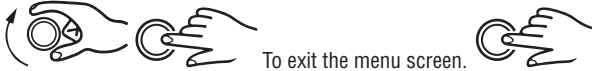

Figure 5.16 - Gas purge screen selected

### 4) MAIN SCREEN

When the main screen is highlighted to enter the main screen.



To exit the menu screen.

### TORCH INSTALLATION OR COVER ASSEMBLY ERROR SCREEN

The torch installation or incorrect cover assembly error screen is displayed when the torch or torch consumable are not installed correctly.

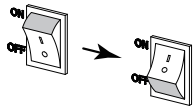

Check the torch and consumable installation.



Figure 5.17 - Torch or consumables installation error screen

### ELECTRODE OR NOZZLE INSTALLATION ERROR SCREEN

The electrode or cutting nozzle installation error screen is displayed when the electrode or cutting nozzle are not installed correctly. The gas flows for 2 seconds and then stops for 3 seconds. The machine continues to check the electrode and cutting nozzle situation until they are in the correct position.

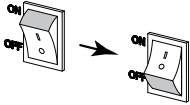

Check or replace the worn cutting nozzle and electrode.



Figure 5.18 - Electrode or cutting nozzle installation error screen

### AIR PRESSURE ERROR SCREEN

The air pressure error screen is displayed when the output air pressure is out of range. Adjust the compressed air pressure between 6 and 8 bar. The error alarm will deactivate.



Figure 5.19 - Air pressure error screen

### VOLTAGE ERROR SCREEN

The voltage error screen is displayed when the input voltage is very low or when the PFC circuit fails. In this case, it is advisable to contact an ESAB Authorized Service Center to assess the equipment.

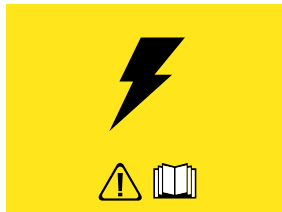

Figure 5.20 - Voltage error screen



## OVERHEATING ERROR SCREEN

The cutting equipment is protected by a temperature sensor. The overheating error screen is displayed if the machine is overheated, which normally occurs if the equipment work cycle is exceeded.

If the overheating error screen displays the machine output, it shall be deactivated. Let the equipment ON to allow the internal components to cool down. When the equipment is cool enough, the overheating error screen disappears automatically.

Notice that the ON/OFF switch must remain in the ON position, so that the fan continues to operate and allow the equipment to cool down enough.



In case of overheating, DO NOT

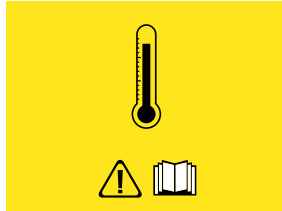
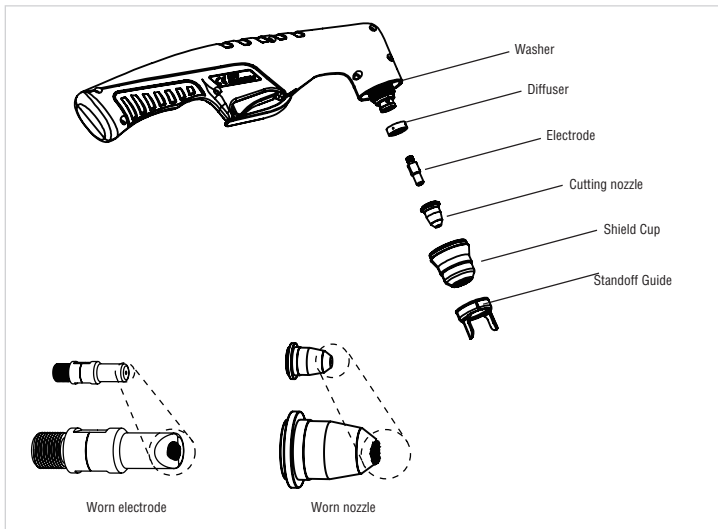

Figure 5.21 - Overheating error screen

## TORCH PART SELECTION

Inspect the torch regarding appropriate assembly and parts. The torch parts must correspond to the current type of work operation. Only use original ESAB parts.



## GAS SELECTION

Ensure that the gas supply meets the listed requirements. Check the connections and open the power supply.

## OPERATION SEQUENCE

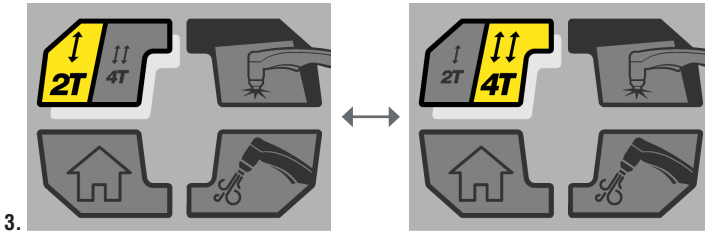
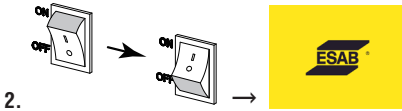
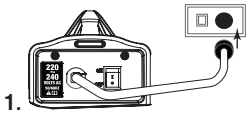

5. Check the air pressure.



To activate the gas purge function. The gas flows and the screen displays the air pressure. Ensure that the pressure is in the correct range of 4.1 bar to 5.5 bar. Note that the equipment has adjusted the gas pressure to 4.6 bar as the standard value.



6. Select the main screen icon and press the control button to exit the menu screen.

7. Adjust the output current value using the front panel control button.



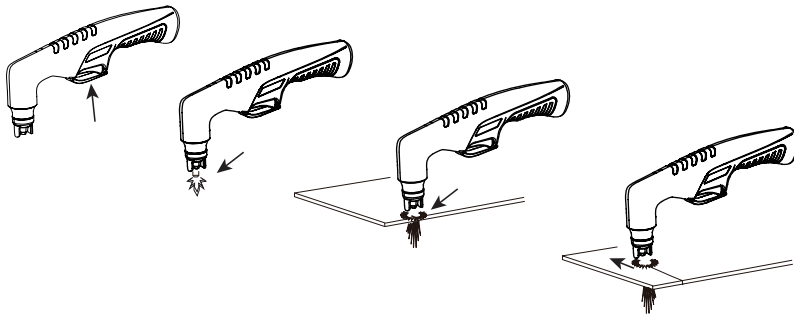

9.

Starting in the middle of the workpiece may damage the shielding cup or the Standoff Guide and reduce the tip service life.



**NOTE!**

For best parts performance and life, always use the correct parts for the type of operation. Please use the Standoff Guide when piercing or drag cutting.

The torch can be comfortably held in one hand or steadied with two hands. Position the hand to press the Trigger on the torch handle. With the hand torch, the hand may be positioned close to the torch head for maximum control or near the back end for maximum heat protection. Choose the holding technique that feels most comfortable and allows good control and movement.

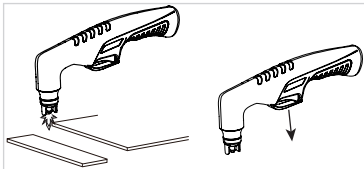

10.

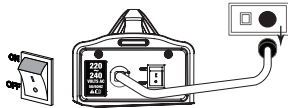

11.

## Cut quality



### NOTE!

Cut quality depends heavily on setup and parameters such as torch standoff, alignment with the workpiece, cutting speed, gas pressures, and operator ability.

Cut quality requirements may differ depending on application. For instance, nitride build-up and bevel angle may be major factors when the surface will be welded after cutting. Dross-free cutting is important when finish cut quality is desired to avoid a secondary cleaning operation. The following cut quality characteristics are illustrated in the following figure:

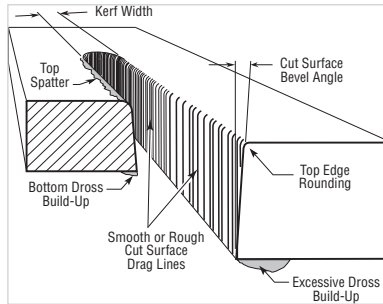
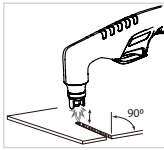

Figure 5.22 - Cut quality characteristics

**Nitride Build-Up** - Nitride deposits can be left on the surface of the cut when nitrogen is present in the plasma gas stream. These build-ups may create difficulties some materials to be welded after the cutting process.



### Torch Standoff -

**Edge Starting** - For edge starts, hold the torch perpendicular to the workpiece with the front of the tip near (not touching) the edge of the workpiece at the point where the cut is to start. When starting at the edge of the plate, do not pause at the edge and force the arc to “reach” for the edge of the metal. Establish the cutting arc as quickly as possible.

**Direction of Cut** - In the torches, the plasma gas stream swirls as it leaves the torch to maintain a smooth column of gas. This swirl effect results in one side of a cut being more square than the other. Viewed along the direction of travel, the right side of the cut is more square than the left.

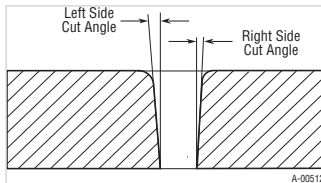

Figure 5.23 - Side Characteristics Of Cut

To obtain a more square cut along the internal diameter of the circle, the torch must move in the counter-clockwise direction or around the circle. To maintain a square edge along when cutting along the external diameter, the torch must move in the clockwise direction.

**Slag** - When dross is present on carbon steel, it is commonly referred to as either “high speed, slow speed, or top dross”.

Dross present on top of the plate is normally caused by too great a torch to plate distance.

“Top dross” is normally very easy to remove and can often be wiped off with a welding glove. “Slow speed dross” is normally present on the bottom edge of the plate.











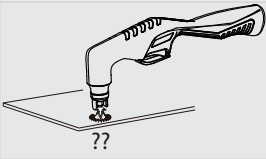





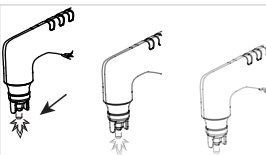



It can vary from a light to heavy bead, but does not adhere tightly to the cut edge, and can be easily scraped off.

“High speed dross” usually forms a narrow bead along the bottom of the cut edge and is very difficult to remove.

When cutting a troublesome steel, it is sometimes useful to reduce the cutting speed to produce “slow speed dross”.

Any resultant cleanup can be accomplished by scraping, not grinding. Depending on the material cut, the operator may want to grind the surface of the cut before welding.

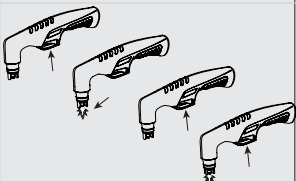
### Common Faults

TABLE 5.2					
PROBLEM - SYMPTOM		COMMON CAUSE			
	<ol style="list-style-type: none"> <li></li> <li></li> </ol>	<ol style="list-style-type: none"> <li></li> <li></li> </ol>	5. Cutting current too low		
	<ol style="list-style-type: none"> <li></li> <li></li> </ol>	<ol style="list-style-type: none"> <li>3. Cutting current too high.</li> <li>4. Work cable disconnected.</li> </ol>	5. 		
	<ol style="list-style-type: none"> <li></li> <li></li> </ol>	<ol style="list-style-type: none"> <li>3. </li> </ol>	4. Improper cutting current.		
Short Torch Parts Life	<ol style="list-style-type: none"> <li></li> <li></li> </ol>	<ol style="list-style-type: none"> <li>3. Excessive pilot arc time</li> </ol>		5. Improperly assembled torch.	
	<ol style="list-style-type: none"> <li>1. </li> </ol>	<ol style="list-style-type: none"> <li>2. </li> </ol>			

## 6 MAINTENANCE

### 6.1 Overview

Periodic maintenance is important to ensure safe and reliable operation.

ESAB recommends that equipment maintenance should only be performed by qualified professionals.



**CAUTION!**

All supplier warranty commitment terms shall no longer be applied if the client attempts to repair any product faults during the warranty period.

### 6.2 Preventive maintenance

In normal operational conditions, the equipment does not require special maintenance service.

Operator can occasionally blow any debris away with low pressure compressed air. Operator should regularly check if any external electrical connections are tight and component wiring is fastened. Check for the eventual presence of cracks in electrical cable or wire insulations, including cutting, or other insulators, and replace as required.



**CAUTION!**

Disconnect all power before performing ANY service.

### 6.3 Corrective maintenance

Use only original ESAB consumables, torch and leads. Using non-original or unapproved parts lead to automatic cancellation of the warranty provided.

Replacement torch and leads can be obtained from ESAB authorized services or from the sales branches indicated in the last page herein. Always reference the model number of the equipment ordered.

## 6.4 Equipment preventive maintenance plan



**Warning!**  
**Disconnect input power before maintaining.**

Maintain more often  
 if used under severe  
 conditions

### Each Use

Visual check of  
 torch tip and electrode



### Weekly

Visually inspect the torch body, washer,  
 diffuser, electrode, cutting nozzle, shield cup,  
 and standoff guide tip.



Visually inspect the  
 cables and leads.  
 Replace as needed

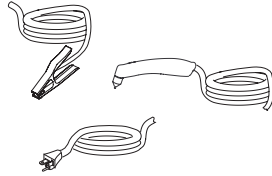

### 3 Months

Replace all  
 broken parts

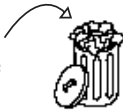

Clean  
 exterior  
 of power supply



Check the external air filter.  
 (Turn the equipment OFF.  
 Close the gas supply and bleed.)  
 Replace as needed.

Art. # A-07938NEW



### NOTE!

Leave the internal earth wire in the correct place.

# 7 PLASMA TORCH

## 7.1 Specifications

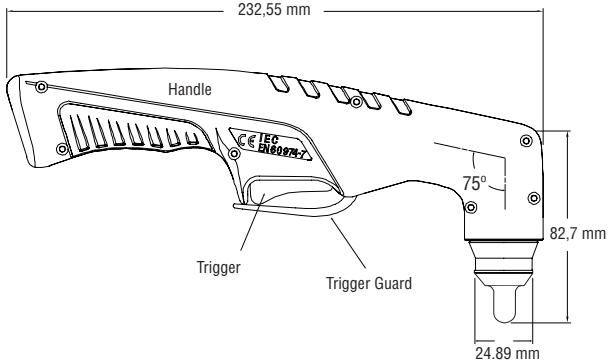

Figure 7.1 - Plasma Torch

### Torch Leads Lengths

The torch cable is 5m long.

### Torch consumables

The torch consists of the following consumable parts: Electrode, nozzle, cover, gas diffuser, and Standoff Guide.

The HandyPlasma 60A Torch (Part No. 0559337000) is equipped with a 0.8 mm Tip for HandyPlasma 35i, and 0.9mm Cutting Tip for HandyPlasma 45i.

### Embedded Parts

The plasma torch head has an embedded circuit switch with rated voltage of 12 VDC.

### Type Cooling

Combination of ambient air and gas stream through torch.

### Torch technical specifications

TABLE 7.1	
TECHNICAL SPECIFICATIONS	HANDYPLASMA TORCH
Ambient Temperature	40° C
Rated Current	60 Amps
Operation Cycle	60%
Rated Voltage	500 V
Gas Flow	110 - 150 LPM



## 7.2 Introduction to Plasma

### 7.2.1. Plasma Gas Flow

Plasma is a gas which has been heated to an extremely high temperature and ionized so that it becomes electrically conductive. The plasma arc cutting and gouging processes use this plasma to transfer an electrical arc to the workpiece. The metal to be cut or removed is melted by the heat of the arc and then blown away.

In a Plasma Cutting Torch a cool gas enters Zone B, where a pilot arc between the electrode and the torch tip heats and ionizes the gas. The main cutting arc then transfers to the workpiece through the column of plasma gas in Zone C.

By forcing the plasma gas and electric arc through a small orifice, the torch delivers a high concentration of heat to a small area. The stiff, constricted plasma arc is shown in Zone C. Direct current (DC) straight polarity is used for plasma cutting, as shown in the illustration.

Zone A channels a secondary gas that cools the torch. This gas also assists the high velocity plasma gas in blowing the molten metal out of the cut allowing for a fast, slag-free cut.

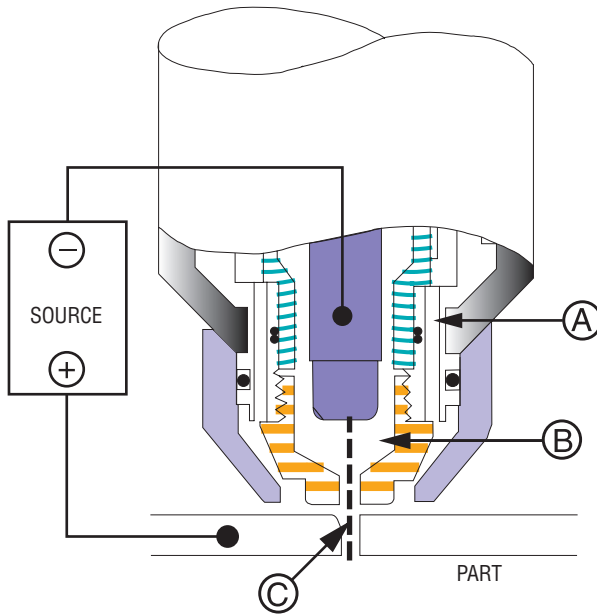

Figure 7.2 - Typical Torch Head Detail

### Gas Distribution

The single gas used is internally split into plasma and secondary gases.

The plasma gas flows into the torch through the negative lead, through the starter cartridge, around the electrode, and out through the tip orifice.

The secondary gas flows down around the outside of the torch starter cartridge, and out between the tip and shield cup around the plasma arc.

### Main cutting arc

DC power is also used for the main cutting arc. The negative output is connected to the torch electrode through the torch lead. The positive output is connected to the workpiece via the work cable and to the torch through a pilot wire.

## 7.3 Torch maintenance

### Cleaning the Torch

Even if precautions are taken to use only clean air with a torch, eventually the inside of the torch becomes coated with residue. This build-up can affect the pilot arc ignition and the overall cut quality of the torch.



#### CAUTION!

Disconnect primary power to the system before disassembling the torch or torch leads.  
DO NOT touch any internal torch parts while the AC indicator light of the Power Supply is ON.



#### CAUTION!

The inside of the torch should be cleaned with electrical contact cleaner using a cotton swab or soft wet rag. In severe cases, the torch can be removed from the leads and cleaned more thoroughly by pouring electrical contact cleaner into the torch and blowing it through with compressed air.

### Inspection and replacement of torch consumables

Remove the consumable torch parts as follows:

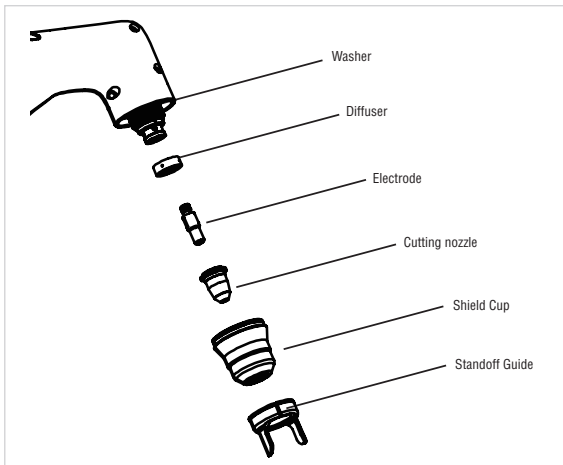
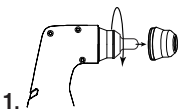

Figure 7.3 - Consumable Parts



1.



#### NOTE!

Slag built up on the shield cup that cannot be removed may affect the performance of the system.



Figure 7.4 - Tip wear

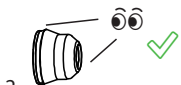

2.

Wipe it clean or replace if damaged.

3. Remove the tip. Check for excessive wear (indicated by an elongated or oversized orifice). Clean or replace the tip if necessary.

4. Check in Torch head if the electrode holder moves freely in and out. Push the electrode in approximately 2 mm, release and it should spring back out. Replace the torch if this does not work.

## 8 TROUBLESHOOTING GUIDE



### WARNING!

There are extremely dangerous voltage and power levels present inside this unit. Do not attempt to diagnose or repair unless you have had training in power electronics measurement and troubleshooting techniques.

If the main complex sub-assemblies are defective, the power supply must be returned to an authorized ESAB service provider for repair. The basic problem solution level can be performed without equipment or special knowledge.

TABLE 8.1				
PROBLEM	CAUSE		SOLUTION	
<p>1.</p>	<p>A) </p> <p>B) </p>	<p>C) Real input voltage does not correspond to the 240 V required by the unit.</p> <p>D) Faulty components in unit.</p>	<p>A) </p> <p>B) </p>	<p>C) Ensure that the power supply is within 240 VAC +/- 15%, and then</p> <p></p>
<p>2.</p>	<p>A) Torch not properly connected to power supply.</p>	<p>B) </p> <p>C) </p>	<p>A) Reinstall the torch; check if the burner is completely installed in the burner female adapter and turn the burner plastic nut clockwise to fix in position.</p>	<p>B) </p>
<p>3.</p>	<p>A) Input air pressure too low or too high.</p> <p>B) Gas line contains impurities.</p>	<p>C) </p> <p>D) Faulty components in unit.</p>	<p>A) Adjust the input air pressure to 6 bar–8 bar.</p> <p>B) Disconnect the gas hose from the rear of the power supply or feeder and blow the impurities.</p>	<p>C) Check if there is gas leakage between the gas valve and the gas input or cylinder output.</p>
<p>4.</p>	<p>A) Electrode or tip not installed correctly.</p> <p>B) </p>	<p>C) </p> <p>D) Power supply component failure.</p>	<p>A) Reinstall the electrode or tip.</p>	<p>B) </p>
<p>5.</p>	<p>A) The main supply voltage is not within the interval.</p>	<p>B) Power supply component failure.</p>	<p>A) Check if the input voltage is within the range of 204–276 V.</p>	
<p>6.</p>	<p>A) The power supply work cycle has been exceeded</p> <p>B) The air flow through or around the unit is blocked.</p>	<p>C) Fan failure.</p> <p>D) Power supply component failure.</p>	<p>A) Leave the power supply on and let it cool down. Note that the Overheating Error Screen must close before the beginning of the cut.</p> <p>B) Maintain the ventilation gap.</p>	<p>C) Check if the fan operates when the main switch is ON.</p>

## 9 PARTS LISTS

Consumables, torches, leads, and accessories are available through a local authorized ESAB Distributor.

### 9.1 Consumable Parts for 60A Torch (P/N 0559337000)

Item #	Qty	Description	Catalog #
1	1	Cutting Tip 35A	0559337001
		Cutting Tip 45A	0559337002
2	1	Electrode	0559337003
3	1	Standoff Guide	0559337004
4	1	Shield Cup	0559337005
5	1	O-Ring	0559337006
6	1	Gas Diffuser	0559337007
7	1	HandyPlasma 60A Torch	0559337000

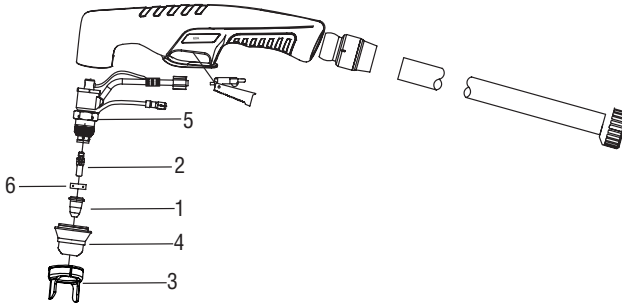

### 9.2 Options and Accessories

Item #	Description	Catalog #
1	Inline Air Filter	0559337039
2	Plasma Filter Cartridge	0559337040
3	Circle Cutting Guide	0559337041

This page intentionally left blank.



[www.esab.com](http://www.esab.com)

©2020 ESAB Welding and Cutting Products